

An underwater photograph of a swimmer in a pool lane. The swimmer is in a streamlined position, moving from the top right towards the bottom left. The water is clear and blue, with light rays filtering through. Lane lines are visible as dark diagonal lines. The swimmer's arms are extended forward, and their legs are tucked. The overall mood is dynamic and athletic.

H₂O SPORT PROJECT

Pool Collection

RICCHETTI GROUP



PoolCollection

Cerdisa offre un'ampia gamma di prodotti dedicati alle piscine, sia pubbliche che sportive.

Nasce così
H₂O Sport Project

Cerdisa offers a wide range of products for both public and sports swimming-pools.
So arise H₂O Sport Project

Cerdisa bietet ein breit gefächertes Produktsortiment für öffentliche und sportliche Schwimmbäder.
Dadurch entsteht H₂O Sport Project

Cerdisa offre une ample gamme de produits dédiés aux piscines, tant publiques que sportives.
Voilà la naissance de H₂O Sport Project

Cerdisa ofrece una amplia gama de productos dedicados a las piscinas, tanto públicas como deportivas.
Así nace H₂O Sport Project





Sistema Finlandese
Finnish System / Finnische System / Système Finlandais / Sistema Finlandés



H₂O SPORT PROJECT

Gres porcellanato smaltato EN 14411 B1a

Glazed porcelain stoneware / Glasiertes Feinsteinzeug / Grès cérame émaillé / Gres porcelánico esmaltado

Matt

Matt



A Matt > 0,60 dry / < 0,50 wet
B Matt > 0,60 dry / > 0,60 wet
C Matt > 0,60 dry / > 0,60 wet
Brillanti > 0,60 dry / < 0,50 wet

M12,5x25

5"x10"

SUPERFICI NATURALI MATT / NATURAL MATT SURFACES / NATUROBERFLÄCHE MATT / SURFACE NATURELLE MATT / SUPERFICIE NATURAL MATE



- 0003322**
Bianco
White / Weiss
Blanc / Blanco
12,5x25
- 0003300**
Grigio Perla
Pearl Grey / Perlgrau
Gris Perle / Gris Perla
12,5x25
- 0003301**
Grigio Argento
Silver Grey / Silbergrau
Gris Argent / Gris Plata
12,5x25
- 0003302**
Grigio Acciaio
Steel Grey / Stahlgrau
Gris Acier / Gris Acero
12,5x25
- 0003303**
Grigio Piombo
Lead Grey / Bleigrau
Gris Plomb / Gris Plomo
12,5x25
- 0003304**
Grigio Profondo
Deep Grey / Dunkelgrau
Gris Profond / Gris Profundo
12,5x25
- 0003305**
Grigio Antracite
Anthracite Grey / Antrazit
Gris Anthracite / Gris Antracite
12,5x25
- 0003324**
Nero
Black / Schwarz
Noir / Negro
12,5x25

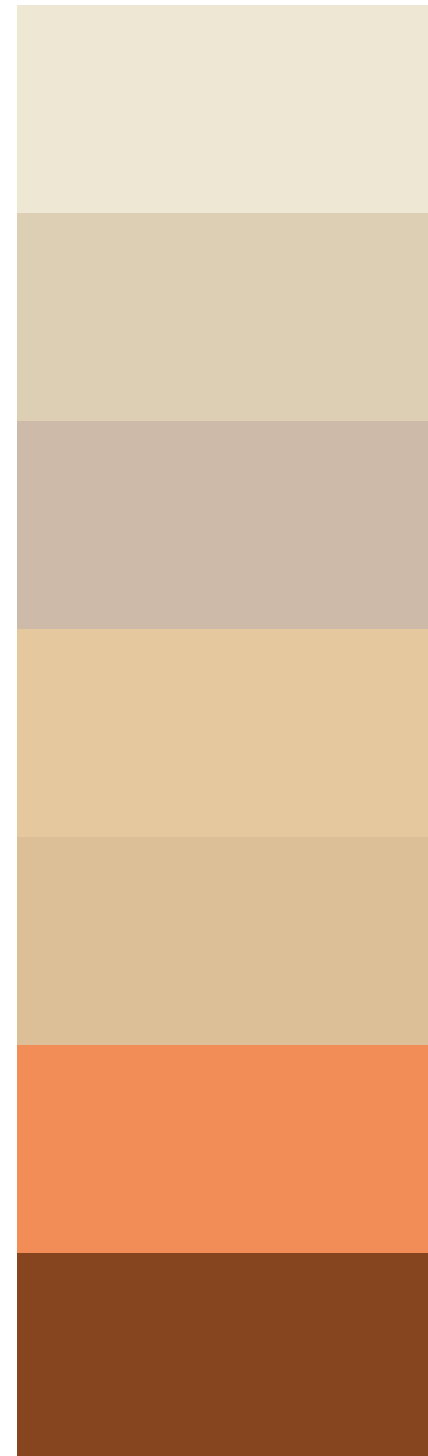

- 0003306**
Gelsomino
Jasmine / Jasmin
Jasmin / Jazmín
12,5x25
- 0003308**
Sabbia
Sand / Sand
Sable / Arena
12,5x25
- 0003309**
Beige
Beige / Beige
Beige / Beige
12,5x25
- 0003311**
Beige Kalahari
Kalahari Beige / Kalaharibeige
Beige Kalahari / Beige Kalahari
12,5x25
- 0003310**
Beige Bahamas
Bahama Beige / Bahamabeige
Beige Bahamas / Beige Bahamas
12,5x25
- 0003307**
Mandarino
Tangerine / Tangerina
Clementine / Naranja
12,5x25
- 0003312**
Cognac
Cognac / Kognak
Cognac / Coñac
12,5x25

Matt

Matt

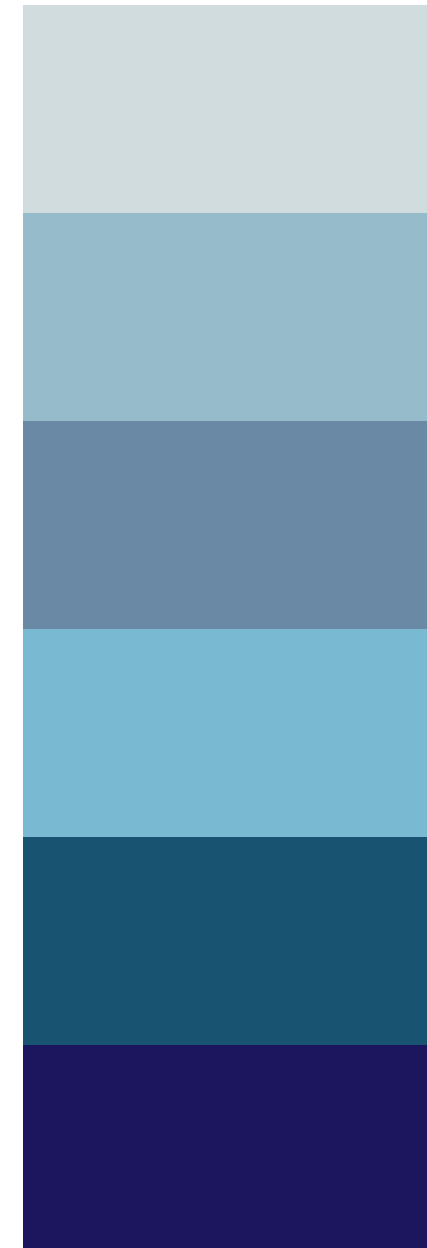

- 0003313**
Azzurro Ghiaccio
Ice Blue / Eisblau
Bleu Glace / Azul Hielo
12,5x25
- 0003314**
Azzurro Celeste
Sky Blue / Himmelblau
Bleu Ciel / Azul Cielo
12,5x25
- 0003315**
Azzurro Atlante
Atlas Blue / Atlasblau
Bleu Atlas / Azul Atlas
12,5x25
- 0003316**
Azzurro Caraibico
Caribbean Blue / Karibikblau
Bleu caribes / Azul Caribe
12,5x25
- 0003317**
Azzurro Petrolio
Petrol Blue / Petrolblau
Bleu Petrole / Azul Petróleo
12,5x25
- 0003323**
Blu Cobalto
Cobalt / Kobaltblau
Cobalt / Cobalto
12,5x25

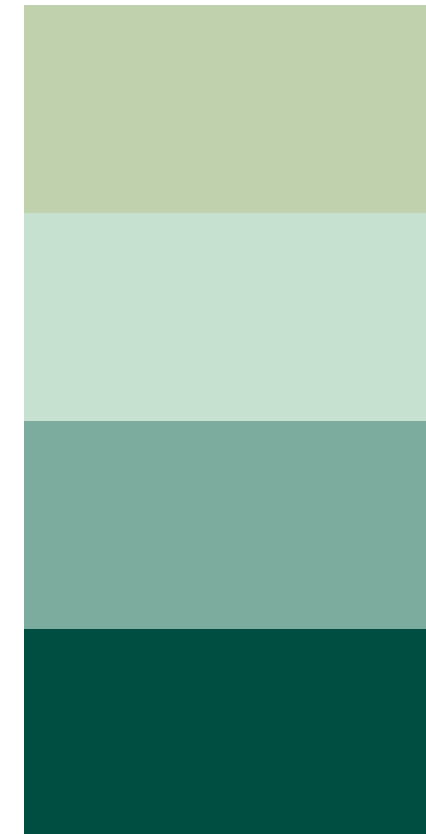

- 0003318**
Verde Menta
Mint Green / Mintgrün
Vert Menthe / Verde Mentol
12,5x25
- 0003320**
Verde Acqua
Water Green / Wassergrün
Vert d'Eau / Verde Agua
12,5x25
- 0003321**
Verde Mare
Sea Green / Seegrün
Vert Marin / Verde Mar
12,5x25
- 0003319**
Verde Vittoriano
Victorian Green / Victoriagrün
Vert Victoria / Verde Victoriano
12,5x25

La superficie di vendita M12,5x25 cm è calcolata sulla base della dimensione convenzionale, uguale alla dimensione nominale più una fuga di 5 mm.
Sales area 5"x9"^{7/8} calculated on the basis of the standard size, equal to the nominal size plus a 5 mm joint / Verkaufsoberfläche M12,5x25 cm unter der Grundlage konventioneller Abmessungen gleich der Nennabmessungen plus einer Fuge von 5 mm / Surface de vente M12,5x25 cm calculées sur la base de la dimension conventionnelle, égale à la dimension nominale plus joint de 5 mm / La superficie de venta M12,5x25 cm se calcula sobre la base de tamaño convencional, igual al tamaño nominal más una distancia de separación de 5 mm.

H₂O SPORT PROJECT

Gres porcellanato smaltato EN 14411 Bla

Glazed porcelain stoneware / Glasiertes Feinsteinzeug / Grès cérame émaillé / Gres porcelánico esmaltado

M12,5x25

5"x10"



B Matt



C Matt

SUPERFICI ANTISCIVOLO B MATT / SLIP RESISTANT SURFACES / TRITTSICHER OBERFLÄCHE / SURFACE ANTIDÉRAPANTE / SUPERFICIE ANTIDESLIZANTE

	0003333 Bianco White / Weiss Blanc / Blanco 12,5x25
	0003329 Gelsomino Jasmine / Jasmin Jasmin / Jazmín 12,5x25
	0003330 Azzurro Caraibico Caribbean Blue / Karibikblau Bleu caribes / Azul Caribe 12,5x25
	0003331 Verde Acqua Water Green / Wassergrün Vert d'Eau / Verde Agua 12,5x25
	0003332 Verde Mare Sea Green / Seegrün Vert Marin / Verde Mar 12,5x25
	0003334 Blu Cobalto Cobalt / Kobaltblau Cobalt / Cobalto 12,5x25
	0003335 Nero Black / Schwarz Noir / Negro 12,5x25

SUPERFICI ANTISCIVOLO C MATT / SLIP RESISTANT SURFACES / TRITTSICHER OBERFLÄCHE / SURFACE ANTIDÉRAPANTE / SUPERFICIE ANTIDESLIZANTE

	0003339 Bianco White / Weiss Blanc / Blanco 12,5x25
	0003336 Gelsomino Jasmine / Jasmin Jasmin / Jazmín 12,5x25
	0003337 Azzurro Caraibico Caribbean Blue / Karibikblau Bleu caribes / Azul Caribe 12,5x25
	0003338 Verde Acqua Water Green / Wassergrün Vert d'Eau / Verde Agua 12,5x25
	0003340 Blu Cobalto Cobalt / Kobaltblau Cobalt / Cobalto 12,5x25

Brillanti

SUPERFICI BRILLANTI / GLOSS SURFACES / GLÄNZEND OBERFLÄCHE / SURFACE BRILLANT / SUPERFICIE BRILLO

	0003325 Bianco White / Weiss Blanc / Blanco 12,5x25
	0003326 Azzurro Caraibico Caribbean Blue / Karibikblau Bleu caribes / Azul Caribe 12,5x25
	0003328 Blu Cobalto Cobalt / Kobaltblau Cobalt / Cobalto 12,5x25
	0003327 Nero Black / Schwarz Noir / Negro 12,5x25

Gruppo di classificazione Evaluation group / Bewertungsgruppe Groupe d'évaluation / Grupos de evaluación	Angolo minimo di inclinazione Minimum angle of slope / Minimaler Neigungswinkel Angle min. d'inclinaison / Angulo mínimo de inclinación
B	→ ≥18°
C	→ ≥24°

GRUPPO DI VALUTAZIONE	ANGOLO MIN. DI INCLINAZIONE	ELENCO DELLE ZONE BAGNATE CON CALPESTIO A PIEDI SCALZI
B	18°	- CORRIDOI PER CALPESTIO CON PIEDI SCALZI NON FACENTI PARTE DELLA CATEGORIA A - DOCCE - ZONE DI IMPIANTI DI SPRUZZATURA DI DISINFETTANTI - PASSAGGIO INTORNO ALLE PISCINE - FONDI DI PISCINE BASSE, QUANDO IN DETERMINATI PUNTI DELLA VASCA LA PROFONDITÀ DELL'ACQUA È INFERIORE A 80 CM. - FONDI DI VASCHE IN PISCINE BASSE A ONDE - PIANI DI SOLLEVAMENTO - PISCINE PER BAMBINI - SCALE A PIOLI CHE PORTANO IN ACQUA - SCALE CHE PORTANO IN ACQUA CON LARGHEZZA MAX DI 1 M. CON CORRIMANO SU ENTRAMBI I LATI - SCALE A PIOLI E SCALE ALL'ESTERNO DELLA ZONA DELLA VASCA
C	24°	- SCALE CHE PORTANO IN ACQUA NON FACENTI PARTE DELLA CATEGORIA B - VASCHE PER PASSAGGIO - BORDO PISCINA INCLINATO

EVALUATION GROUP	MIN. ANGLE OF SLOPE	LIST OF WET AREAS TO BE WALKED ON BAREFOOT
B	18°	- CORRIDORS USED WHEN BAREFOOT, NOT COVERED BY CATEGORY A - SHOWERS - AREAS WITH SYSTEMS FOR SPRAYING DISINFECTANT - AREAS AROUND THE SWIMMING POOL - BOTTOMS OF SHALLOW SWIMMING POOLS WHEN THE DEPTH OF THE WATER IS LESS THAN 80 CM. AT CERTAIN POINTS IN THE POOL - BOTTOMS OF SHALLOW SWIMMING POOLS WITH WAVE MACHINE - PLATFORMS - BABY POOLS - LADDERS LEADING INTO WATER - STEPS LEADING INTO WATER WITH A MAX. WIDTH OF 1 M. WITH A HANDRAIL ON BOTH SIDES - LADDERS AND STEPS OUTSIDE THE POOL AREA
C	24°	- LADDERS LEADING INTO WATER NOT COVERED BY CATEGORY B - WALK THROUGH POOLS - SLOPING EDGES OF SWIMMING POOLS

BEWERTUNGSGRUPPE	MINDEST-NEIGUNGSWINKEL	RUTSCHHEMMUNG IN BARFUSSBEREICHEN
B	18°	- BARFUSSGÄNGE, SOWEIT SIE NICHT A ZUGEORDNET SIND - DUSCHRÄUME - BEREICHE VON DESINFIZIATIONSSPRÜHANLAGEN - BECKENRANDUMGEHUNGEN - BECKENBÖDEN IN NICHTSCHWIMMERBEREICHEN, WENN IN TEILBEREICHEN DIE WASSERTIEFE WENIGER ALS 80 CM. BETRÄGT - BECKENBÖDEN IN NICHTSCHWIMMERBEREICHEN VON WELLENBÄDERN - HUBBÖDEN - KINDERPLANSCHBECKEN - INS WASSER FÜHRENDE SPROSSENLEITERN - INS WASSER FÜHRENDE, MAX. 1 M. BREITE TREPPEN MIT BEIDSEITIGEN HANDLÄUFEN - SPROSSENLEITERN UND TREPPEN AUSSERHALB DES BECKENBEREICHES
C	24°	- INS WASSER FÜHRENDE TREPPEN, SOWEIT SIE NICHT B ZUGEORDNET SIND - DURCHGANGSBECKEN - GENEIGTE BECKENRANDAUSBILDUNGEN

GRUPE D'EVALUATION	ANGLE MIN. D'INCLINAISON	LISTE DES ZONES MOUILLEÉS AVEC PIÉTINEMENT PIEDS NUS
B	18°	- COULOIRS DE CHEMINEMENT PIEDS NUS NE FAISANT PAS PARTIE DE LA CATEGORIE A - DOUCHES - ZONES D'INSTALLATION DE VAPORISATION DE DÉSINFECTANTS - PASSAGE AUTOUR DES PISCINES - FONDS DE PISCINES BASSES, AVEC UNE PROFONDEUR INFÉRIEURE À 80 CM EN CERTAINS POINTS - FONDS DU BASSIN DANS LES PISCINES BASSES À VAGUES - PLANS DE SOULÈVEMENT - PISCINES POUR ENFANTS - ÉCHELLES MURALES D'ENTRÉE DANS L'EAU - ESCALIERS D'ENTRÉE DANS L'EAU D'UNE LARGEUR D'1M MAX. AVEC RAMPE DES DEUX CÔTÉS - ÉCHELLES ET ESCALIERS SITUÉS À L'EXTÉRIEUR DE LA ZONE DU BASSIN
C	24°	- ESCALIERS D'ENTRÉE DANS L'EAU NE FAISANT PAS PARTIE DE LA CATEGORIE B - BASSINS DE PASSAGE - BORD DE PISCINE INCLINÉ

GRUPO DE EVALUACIÓN	ANGOLO MÍNIMO DE INCLINACIÓN	ELENCO DE LA ZONAS MOJADAS CON TRAFICO PEATONAL CON PIES DESCALZOS
B	18°	- PASILLOS PARA EL TRÁFICO PEATONAL CON PIES DESCALZOS QUE NO FORMAN PARTE DE LA CATEGORÍA A - DUCHAS - ZONAS DE INSTALACIONES DE PULVERIZACIÓN DE DESINFECTANTES - PASO ALREDEDOR DE LA PISCINA - FONDOS DE PISCINAS BAJAS CUANDO EN DETERMINADOS PUNTOS DE LA PISCINA LA PROFUNDIDAD DEL AGUA ES INFERIOR A 80 CM. - FONDOS DE PISCINAS BAJAS CON OLAS - PLANOS DE ELEVACIÓN - PISCINAS PARA NIÑOS - ESCALERAS DE MANO QUE LLEVAN AL AGUA - ESCALERAS QUE LLEVAN AL AGUA CON UNA ANCHURA MÁX. DE 1 M. CON BARANDILLAS EN AMBOS LADOS - ESCALERAS DE MANO Y ESCALERAS EN EL EXTERIOR DE LA ZONA DE LA PISCINA
C	24°	- ESCALERAS QUE LLEVAN AL AGUA QUE NO FORMAN PARTE DE LA CATEGORÍA B - PISCINAS DE PASO - BORDE DE PISCINA INCLINADO

Imballi / Packing / Verpackungen / Emballages / Embalajes

La superficie di vendita M12,5x25 cm è calcolata sulla base della dimensione convenzionale, uguale alla dimensione nominale più una fuga di 5 mm. Sales area 5"x9"^{7/8} calculated on the basis of the standard size, equal to the nominal size plus a 5 mm joint / Verkaufsoberfläche M12,5x25 cm unter der Grundlage konventioneller Abmessungen gleich der Nennabmessungen plus einer Fuge von 5 mm / Surface de vente M12,5x25 cm calculées sur la base de la dimension conventionnelle, égale à la dimension nominale plus joint de 5 mm / La superficie de venta M12,5x25 cm se calcula sobre la base de tamaño convencional, igual al tamaño nominal más una distancia de separación de 5 mm.



Formato Size Format Formato	Pezzi/Sc. Pcs/Box Pcs/Ctn Stck/Kart Piezas/Caja	Mq/Sc Sq.M/Box Mq/Ctn Qm/Kart Mq/Caja	Sc/Pal Box/Pal Ctn/Pal Kart/Pal Caja/Pal	Mq/Pal Sq.M/Pal Mq/Ctn Qm/Pal Mq/Pal	Kg/Sc Kg/Box Kg/Ctn Kg/Kart Kg/Caja	Kg/Pal Kg/Pal Kg/Pal Kg/Pal Kg/Pal
M12,5x25 5' x 10'	32	1	81	81	14,80	1224

H₂O SPORT PROJECT

Gres porcellanato smaltato EN 14411 Bla

Glazed porcelain stoneware / Glasiertes Feinsteinzeug / Grès cérame émaillé / Gres porcelánico esmaltado

SUPERFICI NATURALE MATT / NATURAL MATT SURFACES / NATUROBERFLÄCHE MATT / SURFACE NATURELLE MAT / SUPERFICIE NATURAL MATE

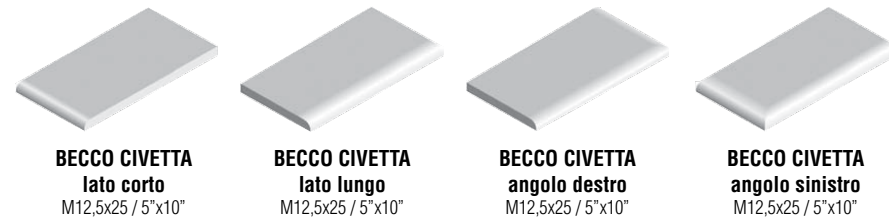

	Bianco	0003366	0003398	0003430	0003462
	Grigio Perla	0003344	0003376	0003408	0003440
	Grigio Argento	0003345	0003377	0003409	0003441
	Grigio Acciaio	0003346	0003378	0003410	0003442
	Grigio Piombo	0003347	0003379	0003411	0003443
	Grigio Profondo	0003348	0003380	0003412	0003444
	Grigio Antracite	0003349	0003381	0003413	0003445
	Nero	0003368	0003400	0003432	0003464
	Gelsomino	0003350	0003382	0003414	0003446
	Sabbia	0003352	0003384	0003416	0003448
	Beige	0003353	0003385	0003417	0003449
	Beige Kalahari	0003355	0003387	0003419	0003451
	Beige Bahamas	0003354	0003386	0003418	0003450
	Mandarino	0003351	0003383	0003415	0003447
	Cognac	0003356	0003388	0003420	0003452
	Azzurro Ghiaccio	0003357	0003389	0003421	0003453
	Azzurro Celeste	0003358	0003390	0003422	0003454
	Azzurro Atlante	0003359	0003391	0003423	0003455
	Azzurro Caraibico	0003360	0003392	0003424	0003456
	Azzurro Petrolio	0003361	0003393	0003425	0003457
	Blu Cobalto	0003367	0003399	0003431	0003463
	Verde Menta	0003362	0003394	0003426	0003458
	Verde Acqua	0003364	0003396	0003428	0003460
	Verde Mare	0003365	0003397	0003429	0003461
	Verde Vittoriano	0003363	0003395	0003427	0003459



M12,5x25
5"x10"

SUPERFICI ANTISCIVOLO B MATT / SLIP RESISTANT SURFACES / TRITTSICHER OBERFLÄCHE / SURFACE ANTIDERAPANT / SUPERFICIE ANTIDESLIZANTE

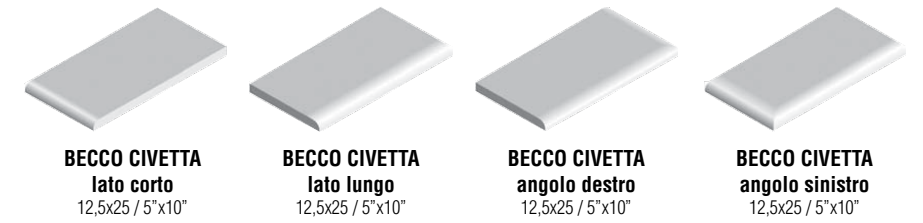

	Bianco	0003373	0003405	0003437	0003469
	Nero	0003375	0003407	0003439	0003471
	Gelsomino	0003369	0003401	0003433	0003465
	Azzurro Caraibico	0003370	0003402	0003434	0003466
	Blu Cobalto	0003374	0003406	0003438	0003470
	Verde Acqua	0003371	0003403	0003435	0003467
	Verde Mare	0003372	0003404	0003436	0003468

INTERNO VASCA / INSIDE THE POOL / BECKEN / INTERIEUR DU BASSIN / INTERIORES DE PISCINA

3 SGUSCIA INTERNA ANGOLO ALTO
 2 SGUSCIA ESTERNA
 5 SGUSCIA ESTERNA ANGOLO ALTO
 4 SGUSCIA INTERNA ANGOLO BASSO
 1 SGUSCIA INTERNA
 6 SGUSCIA ESTERNA ANGOLO BASSO

	SGUSCIA INTERNA 3x25 / 1 ¹⁵ °x10"	SGUSCIA ESTERNA 3x25 / 1 ¹⁵ °x10"	SGUSCIA INTERNA angolo alto 7x3 / 2 ⁴⁵ °x1 ¹⁵ °	SGUSCIA INTERNA angolo basso 3x3 / 1 ¹⁵ °x1 ¹⁵ °	SGUSCIA ESTERNA angolo alto 3,7x3,7 / 1 ¹² °x1 ¹² °	SGUSCIA ESTERNA angolo basso 7x3 / 2 ⁴⁵ °x1 ¹⁵ °
Bianco	0003472	0003475	0003478	0003484	0003487	0003481
Azz. Caraibico	0003473	0003476	0003479	0003485	0003488	0003482

1 2 3 4 5 6

H₂O SPORT PROJECT

PEZZI SPECIALI
SPECIAL TRIMS / SONDERSTÜCKE / PIECES SPECIALES / PIEZAS ESPECIALES

BORDI VASCA / SWIMMING POOL EDGES / BECKENRAND / BORDS DE PISCINE / BORDE DE PISCINA

Gres porcellanato estruso non smaltato EN 14411 Ala

Unglazed extruded porcelain stoneware / Extrudierten unglasiertes Feinsteinzeug / Grès cérame extrudé non émaillé / Gres porcelánico extruido sin esmaltar



1 Bordo vasca rigato
M12,5x25 / 5"x10"

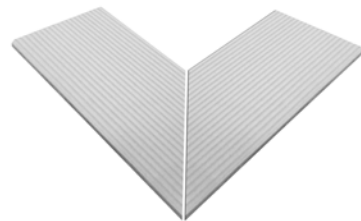

2 Angolo bordo vasca rigato
M12,5x25 / 5"x10"

	M12,5x25 5" x10"	M12,5x25 5" x10"
	0003538	0003539
	0003504	0003505
	1	2



3 Bordo vasca rigato con b.c. blu smaltato
M12,5x25 / 5"x10"

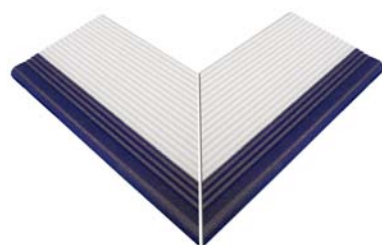

4 Angolo interno bordo vasca rigato con b.c. blu smaltato
M12,5x25 / 5"x10"

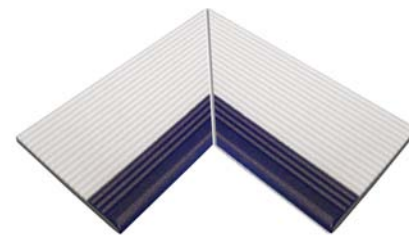

5 Angolo esterno bordo vasca rigato con b.c. blu smaltato
M12,5x25 / 10"x10"

	M12,5x25 5" x10"	M12,5x25 5" x10"	M12,5x25 5" x10"
	0003540	0003541	0003542
	0003506	0003507	0003508
	3	4	5

Imballi / Packing / Verpackungen / Emballages / Embalajes

Formato Size Format Formato	Pezzi/Sc. Pcs/Box Pcs/Ctn Stck/Kart Piezas/Caja	Mq/Sc Sq.M/Box Mq/Ctn Qm/Kart Mq/Caja	Sc/Pal Box/Pal Ctn/Pal Kart/Pal Caja/Pal	Mq/Pal Sq.M/Pal Mq/Pal Qm/Pal Mq/Pal	Kg/Sc Kg/Box Kg/Ctn Kg/Kart Kg/Caja	Kg/Pal Kg/Pal Kg/Pal Kg/Pal Kg/Pal	
M12,5x25 5" x10"	12,5x25	23	0,7	105	73,18	12,19	1300
M12,5x25 5" x10"	12,5x12,5	1	0,01	-	-	0,27	-

Il bordo blu cobalto è smaltato

The cobalt edge is glazed / Kobaltblau Beckenrand ist glasiert / Le bord de piscine cobalt est émaillé / El borde de piscina está esmaltado

Tutti i bordi vasca hanno superficie antiscivolo naturale

All swimming pool edges are natural slip resistant surfaces / Alles Beckenrand sind trittsicher Naturoberfläche / Tous les bords de piscine ont une surface naturelle antidérapante / Todos bordos de piscina son superficie antideslizante natural

CANALE DI RICICLO / RECYCLING CHANNEL / RECYCLING KANAL / CANAL DE RECYCLAGE / CANAL DE RECICLAJE

Gres porcellanato estruso smaltato EN 14411 Ala

Glazed extruded porcelain stoneware / Extrudierten glasiertes Feinsteinzeug / Grès cérame extrudé émaillé / Gres porcelánico extruido esmaltado



0003518
Canale interno di riciclo - 90°
M12,5x25 / 5"x10"



0003519
Canale interno di riciclo - 107°
M12,5x25 / 5"x10"

Imballi / Packing / Verpackungen / Emballages / Embalajes

Formato Size Format Formato	Pezzi/Sc. Pcs/Box Pcs/Ctn Stck/Kart Piezas/Caja	Mq/Sc Sq.M/Box Mq/Ctn Qm/Kart Mq/Caja	Kg/Sc Kg/Box Kg/Ctn Kg/Kart Kg/Caja
12,5x25	16	0,76	12,16

CANALE ACQUA SPORCA / WASTE WATER CHANNEL / SCHMUTZWASSER KANAL / CANAL DE EAU SALE / CANAL DE AGUA SUCIA

Gres porcellanato estruso non smaltato EN 14411 Ala

Unglazed extruded porcelain stoneware / Extrudierten unglasiertes Feinsteinzeug / Grès cérame extrudé non émaillé / Gres porcelánico extruido sin esmaltar



0003514
1 Canale di raccolta
M12,5x25 / 5"x10"



0003515
2 Canale di raccolta e scarico
M12,5x25 / 5"x10"



0003516
3 Canalina di raccolta terminale
M12,5x25 / 5"x10"

Imballi / Packing / Verpackungen / Emballages / Embalajes

Formato Size Format Formato	Pezzi/Sc. Pcs/Box Pcs/Ctn Stck/Kart Piezas/Caja	Mq/Sc Sq.M/Box Mq/Ctn Qm/Kart Mq/Caja	Sc/Pal Box/Pal Ctn/Pal Kart/Pal Caja/Pal	Mq/Pal Sq.M/Pal Mq/Pal Qm/Pal Mq/Pal	Kg/Sc Kg/Box Kg/Ctn Kg/Kart Kg/Caja	Kg/Pal Kg/Pal Kg/Pal Kg/Pal Kg/Pal
--------------------------------------	---	---	--	--	---	--

1	12,5x25	11	0,34	120	41,25	6,97	837
2	12,5x25	11	0,34	120	41,25	6,53	784
3	12,5x25	11	0,34	120	41,25	6,75	810
4	12,5x12,5	5	0,07	-	-	1,64	-



0003517
4 Canalina di raccolta angolare
M12,5x12,5 / 5"x5"

H₂O SPORT PROJECT

PEZZI SPECIALI
SPECIAL TRIMS / SONDERSTÜCKE / PIECES SPECIALES / PIEZAS ESPECIALES

PIATTO DOCCIA / SHOWER / DUSCHE / DOUCHE / DUCHA

Gres porcellanato estruso non smaltato EN 14411 Ala

Unglazed extruded porcelain stoneware / Extrudierten unglasiertes Feinsteinzeug / Grès cérame extrudé non émaillé / Gres porcelánico extruido sin esmalto

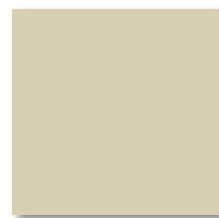
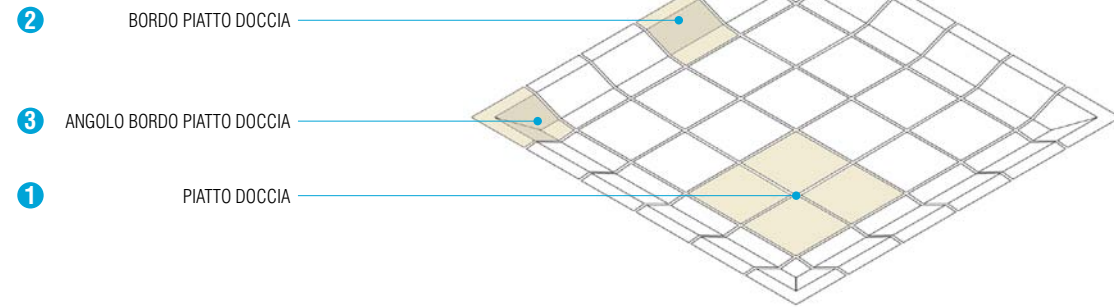

1 0003523
Piatto doccia Bahia
15x15 / 6"x6"



1 0003524
Piatto doccia Weiss-Mix
15x15 / 6"x6"



2 0003525
Bordo piatto doccia Bahia
15x15 / 6"x6"



3 0003527
Angolo bordo piatto doccia Bahia
15x15 / 6"x6"

2 0003526
Bordo piatto doccia Weiss-Mix
15x15 / 6"x6"

3 0003528
Angolo bordo piatto doccia Weiss-Mix
15x15 / 6"x6"

Imballi / Packing / Verpackungen / Emballages / Embalajes

Formato Size Format Format Tamaño	Pezzi/Sc. Pcs/Box Pcs/Ctn Stck/Kart Piezas/Caja	Mq/Sc Sq.M/Box Mq/Ctn Qm/Kart Mq/Caja	Sc/Pal Box/Pal Ctn/Pal Kart/Pal Caja/Pal	Mq/Pal Sq.M/Pal Mq/Pal Qm/Pal Mq/Pal	Kg/Sc Kg/Box Kg/Ctn Kg/Kart Kg/Caja	Kg/Pal Kg/Pal Kg/Pal Kg/Pal Kg/Pal
1 15x15	22	0,5	116	58	8,5	1006
2 15x15	8	0,1	-	-	4,6	-
3 15x15	2	0,04	-	-	1,3	-

SEGNALETICA / MARKING / MARKIERUNGEN / SIGNALISATION / SEÑALIZACIÓN

Gres porcellanato smaltato EN 14411 Ala

Glazed porcelain stoneware / Glasiertes Feinsteinzeug / Grès cérame émaillé / Gres porcelánico esmaltado



0003521
Indicatore di profondità
M12,5x25 / 5"x10"

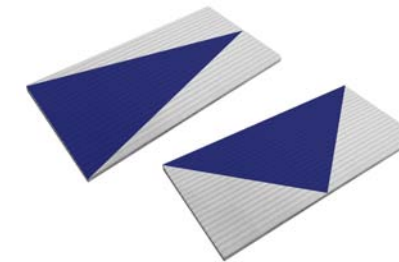

0003522
Indicatori di direzione
M12,5x25 / 5"x10"



0003520
Segnaletica varia
M12,5x25 / 5"x10"

I numeri, gli indicatori e i simboli in generale verranno prodotti in quantità e su richiesta specifica del cliente

Numbers, marks direction and symbols will be produced on specific demand of client

Zahlen, Wegweiser und allerlei Symbole werden je nach Bedarf und Wunsch des Kunden produziert

Tous les numéros, les indicateurs et les symboles seront produits seulement sur demande spécifique du client

Los números, indicadores y símbolos serán producido en la cantidad y a pedida específica del cliente

Segnaletica

Marking / Markierungen / Signalisations / Señalización



GRIGLIE / GRATING / ROST / GRILLE / REJILLA

Griglia perpendicolare arrotolabile

Roll-up perpendicular grating elements / Querverlaufende Überflutungsroste / Grille enroulable perpendiculaires / Rejilla enrollable perpendicular

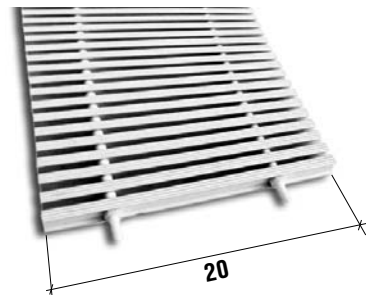

A003474
Griglia perpendicolare Gr2/25



A003477
Griglia perpendicolare curvabile Gr2/25/C

A003480
Griglia perpendicolare Gr2/35



A003489
Angolo per griglia perpendicolare Gr2/25

A003572
Angolo per griglia perpendicolare Gr2/35

Griglia fornita in tronchi standard di 2,5 m

Roll-up supplied in standard sections 2,5 m in length
Rollrost Lieferung in Standardlängen von 2,5 m
Grille fournie en tronçons standard de 2,5 m de longueur
Rejilla suministrada en módulos estandar de 2,5 m de longitud

Griglia parallela rigida

Parallel rigid grating / Längsverlaufende Überflutungsroste / Grille parallèle rigide / Rejilla parallela rigida

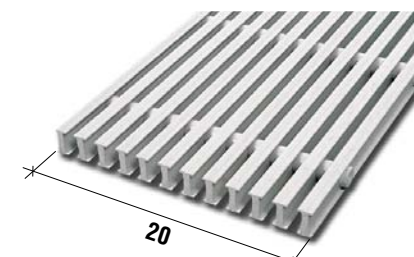

A003483
Griglia parallela Gr20

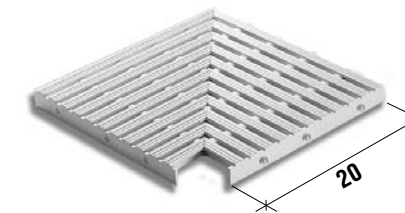

A003637
Angolo per griglia parallela Gr20

Griglia curvabile

Curvable grating / Flexible Überflutungsroste / Grille courvable / Rejilla curvable



A003486
Griglia curvabile Gr47



A003573
Angolo per griglia curvabile Gr47

Griglia fornita in tronchi standard di 1 m

Roll-up supplied in standard sections 1 m in length
Rollrost Lieferung in Standardlängen von 1 m
Grille fournie en tronçons standard de 1 m de longueur
Rejilla suministrada en módulos estandar de 1 m de longitud

PROFILI PER CANALETTE / GUTTER PROFILES / PROFILE FÜR ÜBERFLUTUNGRINNEN / PROFILS POUR CANIVEAUX / PERFILES PARA CANALETAS

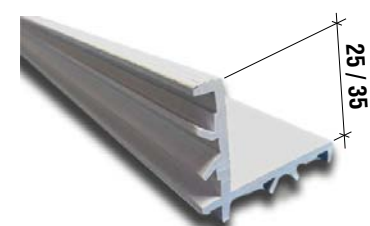

A003574
Profilo in PVC Gr6/25
h 25 mm

A003575
Profilo in PVC Gr6/35
h 35 mm

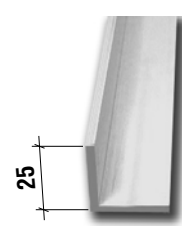

A003576
Profilo in PVC a L Gr6/L
h 25 mm

PILETTE DI SCARICO / DRAINAGE ELEMENTS / ABLAUFVENTILE / BONDES / SUMIDEROS



A003497
Piletta in metallo
silenziosa SIL Gr7
Ø2¹/₂
145 l/min



A003496
Piletta in metallo Gr7
Ø2¹/₂
147 l/min

A003577
Piletta in metallo Gr7
Ø1¹/₂
36 l/min



A003498
Piletta ABS in plastica Gr60
Ø2¹/₂
120 l/min

A003536
Piletta ABS in plastica Gr62
Ø1¹/₂
40 l/min



A003499
Piletta ABS in plastica Gr61
Ø2¹/₂
70 l/min

A003537
Piletta ABS in plastica Gr63
Ø1¹/₂
26 l/min

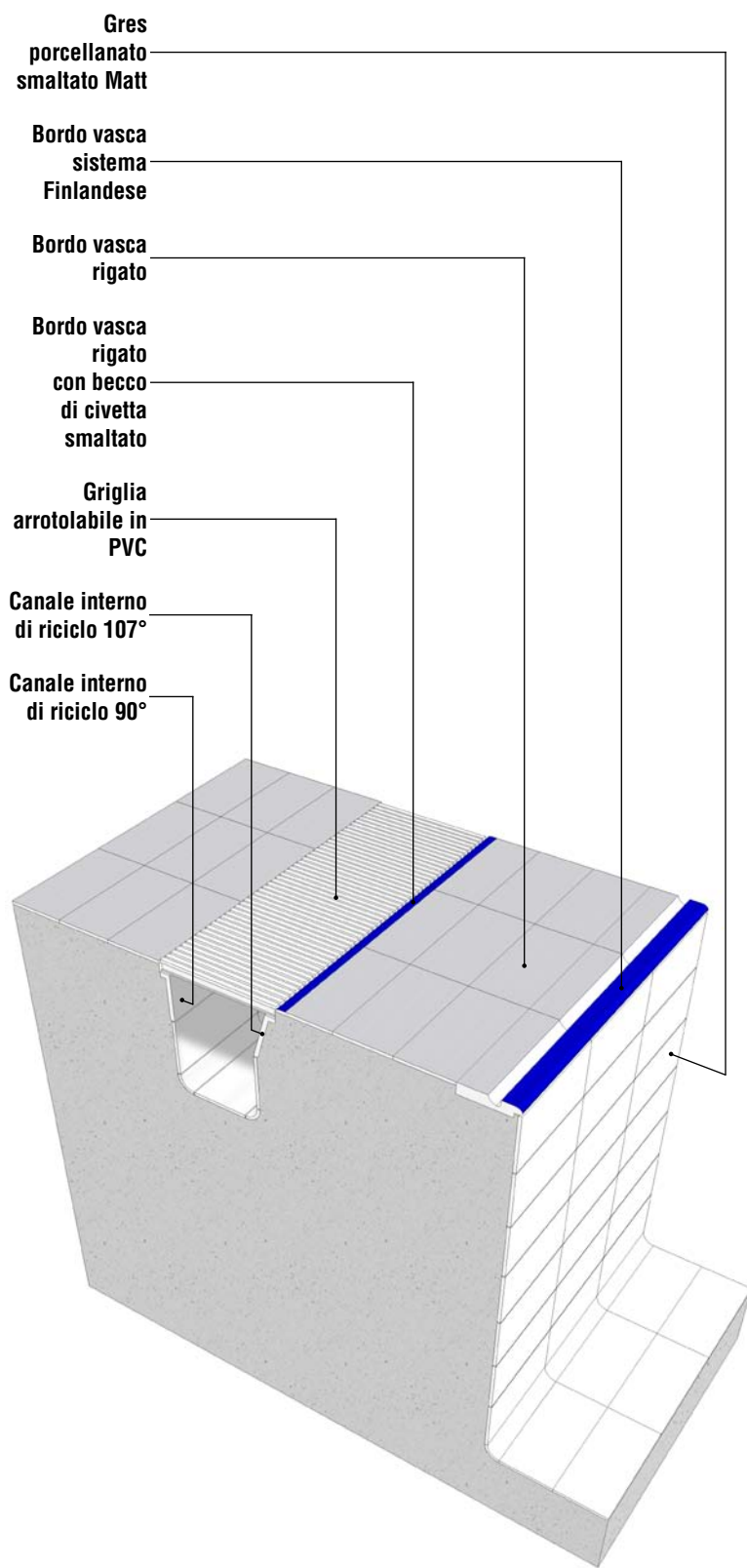

Sistema Finlandese
Finnish System / Finnische System / Système Finlandais / Sistema Finlandés

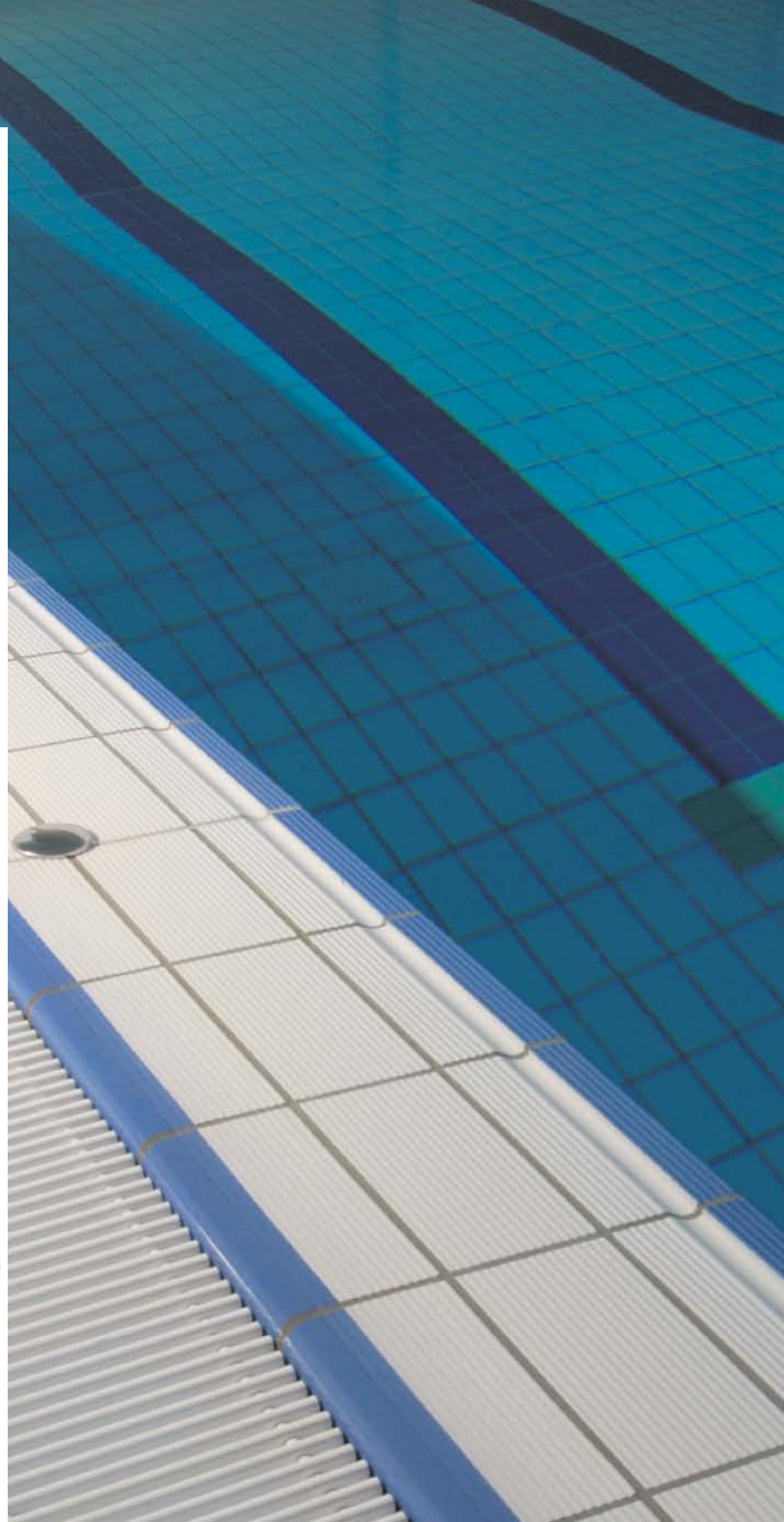

SISTEMA FINLANDESE

FINNISH SYSTEM / FINNISCHE SYSTEM / SYSTÈME FINLANDAIS / SISTEMA FINLANDÉS

Gres porcellanato non smaltato EN 14411 Ala

Unglazed porcelain stoneware / Unglasiertes Feinsteinzeug / Grès cérame non émaillé / Gres porcelánico sin esmaltar



Gres estruso

Extruded stoneware / Extrudierten Feinsteinzeug
Grès extrudé / Gres extruido



1
25 0003490
Bordo vasca
M12,5x25 / 5"x10"

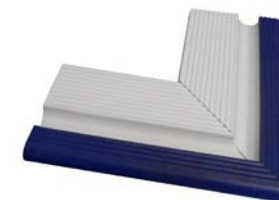

2
25 0003491
Angolo interno bordo vasca
M12,5x25 / 5"x10"

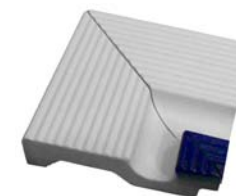

3
25 0003492
Angolo esterno bordo vasca
M12,5x12,5 / 5"x5"

Gres a colaggio

Stoneware in casting / Steinzeug in Gießen
Grès dans la coulée / Gres mediante colada



4
15 0003529
Bordo vasca
M12,5x25 / 5"x10"



5
15 0003530
Angolo interno bordo vasca
M12,5x12,5 / 5"x5"

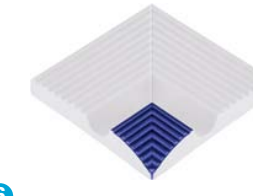

6
15 0003531
Angolo esterno bordo vasca
M12,5x12,5 / 5"x5"

Imballi / Packing / Verpackungen / Emballages / Embalajes

	Formato Size Format Formato	Pezzi/Sc. Pcs/Box Stck/Ctn Piezas/Caja	Mq/Sc Sq. M/Box Mq/Ctn Mq/Caja	Kg/Sc Kg/Box Kg/Ctn Kg/Caja
1	12,5x25	14	0,43	14,56
2	12,5x25	1	0,43	1,6
3	12,5x12,5	1	0,01	0,56
4	12,5x25	12	0,37	6,94
5	12,5x12,5	5	0,07	1,54
6	12,5x25	5	0,07	1,44

Il bordo blu cobalto è smaltato

The cobalt edge is glazed
Kobaltblau Beckenrand ist glasiert
Le bord de piscine cobalto est émaillé
El bordo de piscina cobalto está esmaltado

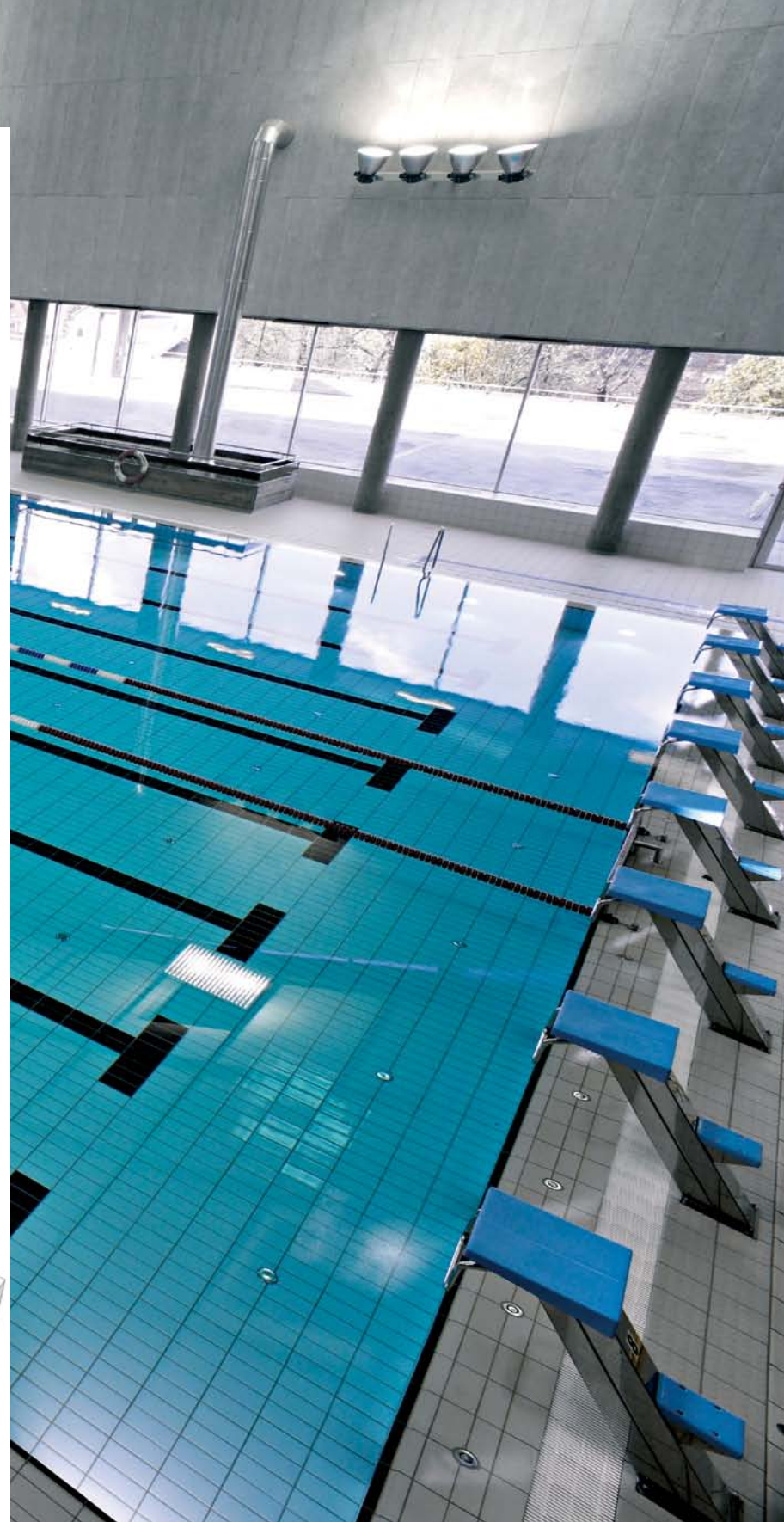
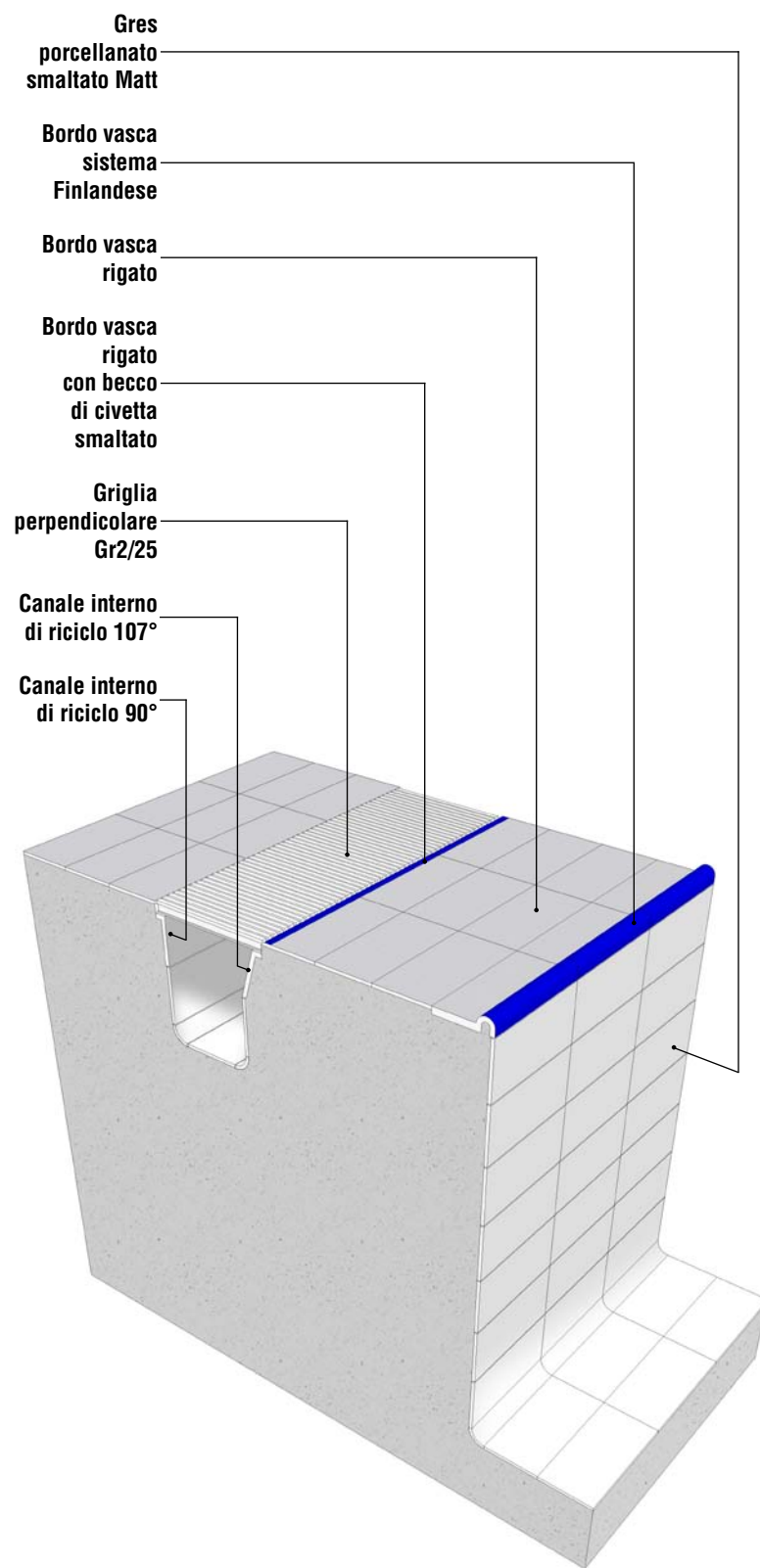

Sistema Zurigo
Zurich System / Zürich System / Système Zurich / Sistema de Zurich

SISTEMA ZURIGO

ZURICH SYSTEM / ZÜRCH SYSTEM / SYSTÈME ZURICH / SISTEMA DE ZURICH

Gres porcellanato non smaltato EN 14411 Ala
Unglazed porcelain stoneware / Unglasiertes Feinsteinzeug
Grès cérame non émaillé / Gres porcelánico sin esmaltar

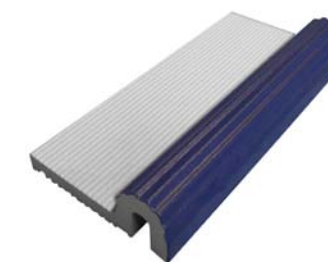

1 0003493
Bordo vasca
M12,5x25 / 5"x10"

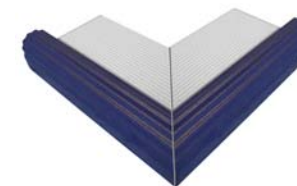

2 0003494
Angolo interno bordo vasca
M12,5x25 / 10"x10"

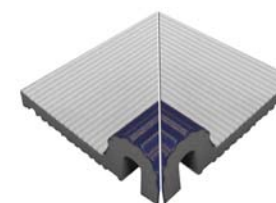

3 0003495
Angolo esterno bordo vasca
M12,5x12,5 / 5"x5"

Imballi / Packing / Verpackungen / Emballages / Embalajes

Formato Size Format Tamaño	Pezzi/Sc. Pcs/Box Pcs/Ctn Stck/Kart Piezas/Caja	Mq/Sc Sq.M/Box Mq/Ctn Qm/Kart Mq/Caja	Kg/Sc Kg/Box Kg/Ctn Kg/Kart Kg/Caja
1 12,5x25	10	0,3	12
2 25x25	1	0,04	1,6
3 12,5x12,5	1	0,01	0,56

Il bordo blu cobalto è smaltato

The cobalt edge is glazed / Kobaltblau Beckenrand ist glasiert / Le bord de piscine cobalt est émaillé / El bordo de piscina cobalto está esmaltado

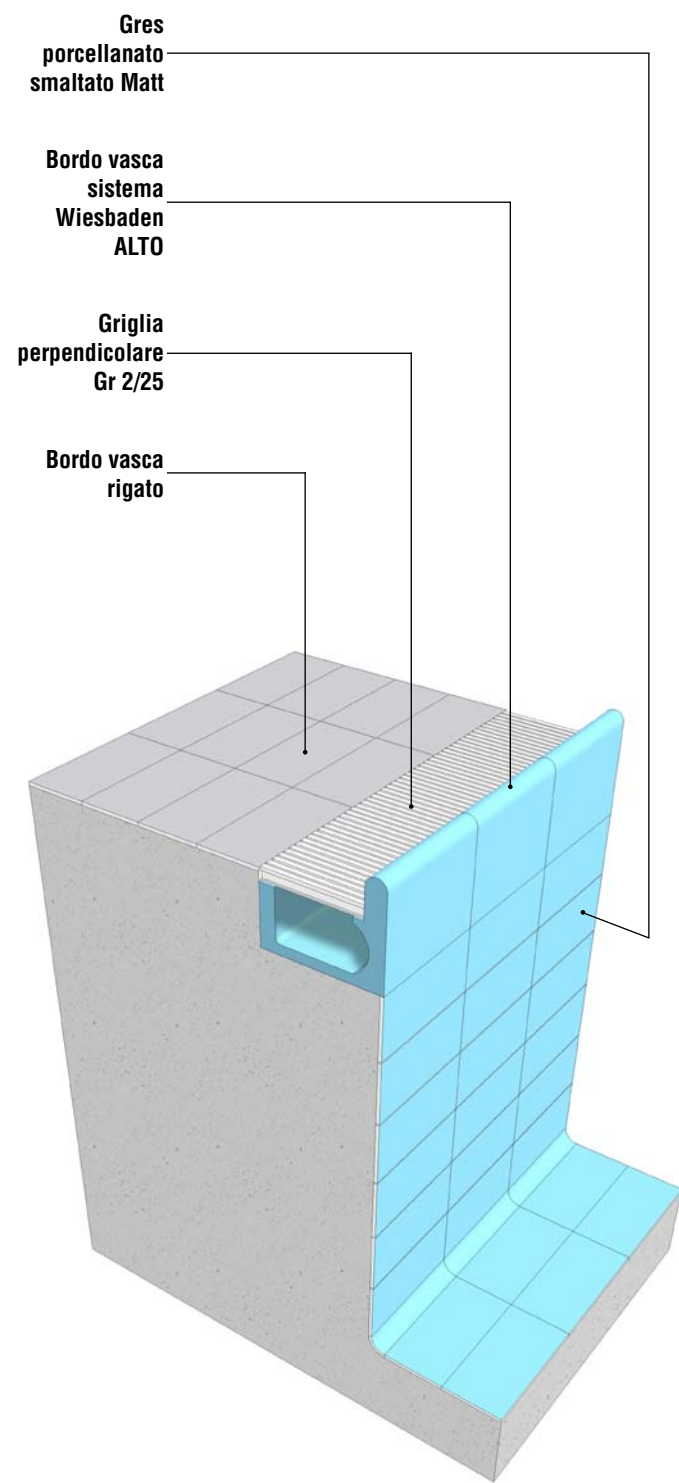

Sistema Wiesbaden
Wiesbaden System / Wiesbaden System / Système Wiesbaden / Sistema de Wiesbaden

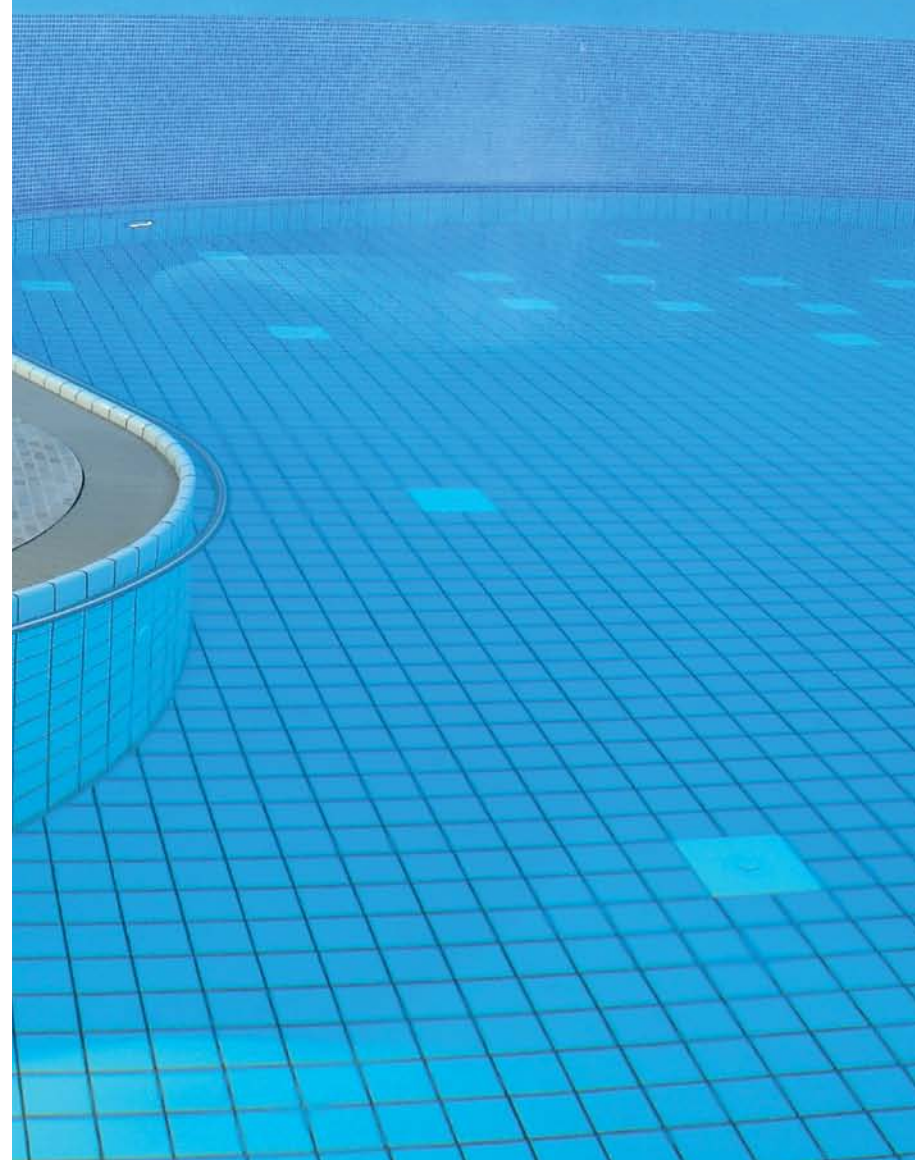

SISTEMA WIESBADEN

WIESBADEN SYSTEM / WIESBADEN SYSTEM / SYSTÈME WIESBADEN / SISTEMA DE WIESBADEN

Gres porcellanato smaltato EN 14411 Ala

Glazed porcelain stoneware / Glasiertes Feinsteinzeug / Grès cérame émaillé / Gres porcelánico esmaltado

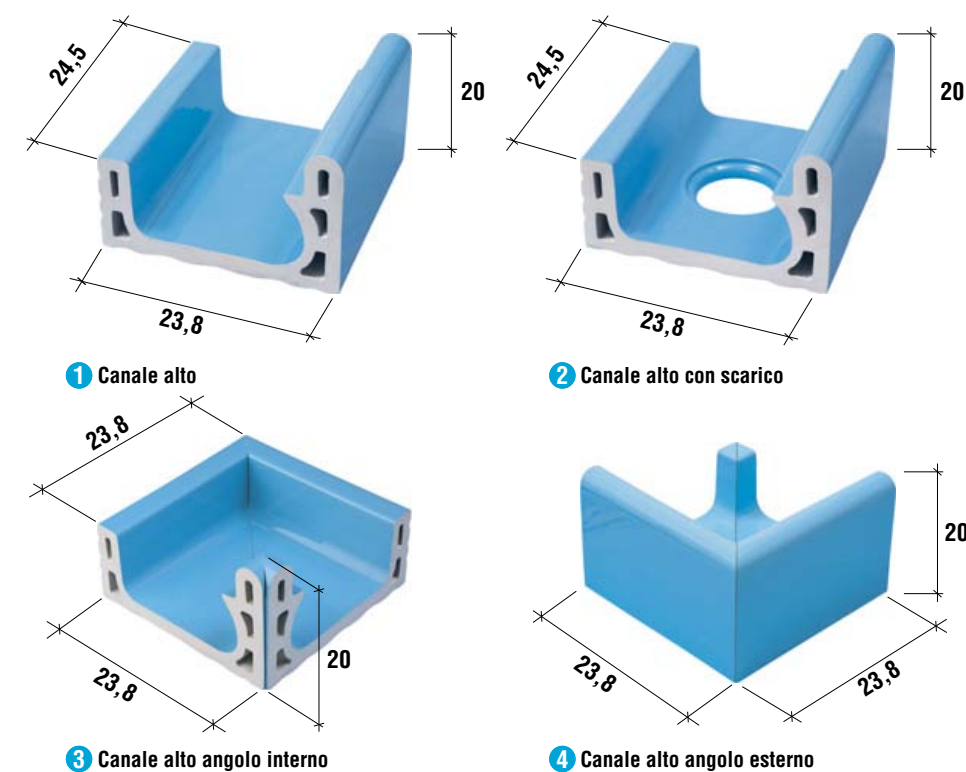

Canale alto
24,5x23,8 / 10"x9 1/2"

Canale alto con scarico
24,5x23,8 / 10"x9 1/2"

Canale alto ang. interno
23,8x23,8 / 9 1/2"x9 1/2"

Canale alto ang. esterno
23,8x23,8 / 9 1/2"x9 1/2"

Azzurro Caraibico 0003564 0003565 0003566 0003567

Imballi / Packing / Verpackungen / Emballages / Embalajes

Formato Size Format Formato Tamaño	Pezzi/Sc. Pcs/Box Pcs/Ctn Stck/Kart Piezas/Caja	Mq/Sc Sq./M/Box Mq/Ctn Qm/Kart Mq/Caja	Kg/Sc Kg/Box Kg/Ctn Kg/Kart Kg/Caja
1 23,8x24,5	1	0,07 / 0,05	6,60
2 23,8x24,5	1	0,07 / 0,05	6,41
3 23,8x23,8	1	0,08 / 0,05	5,58
4 23,8x23,8	1	0,08 / 0,05	5,1

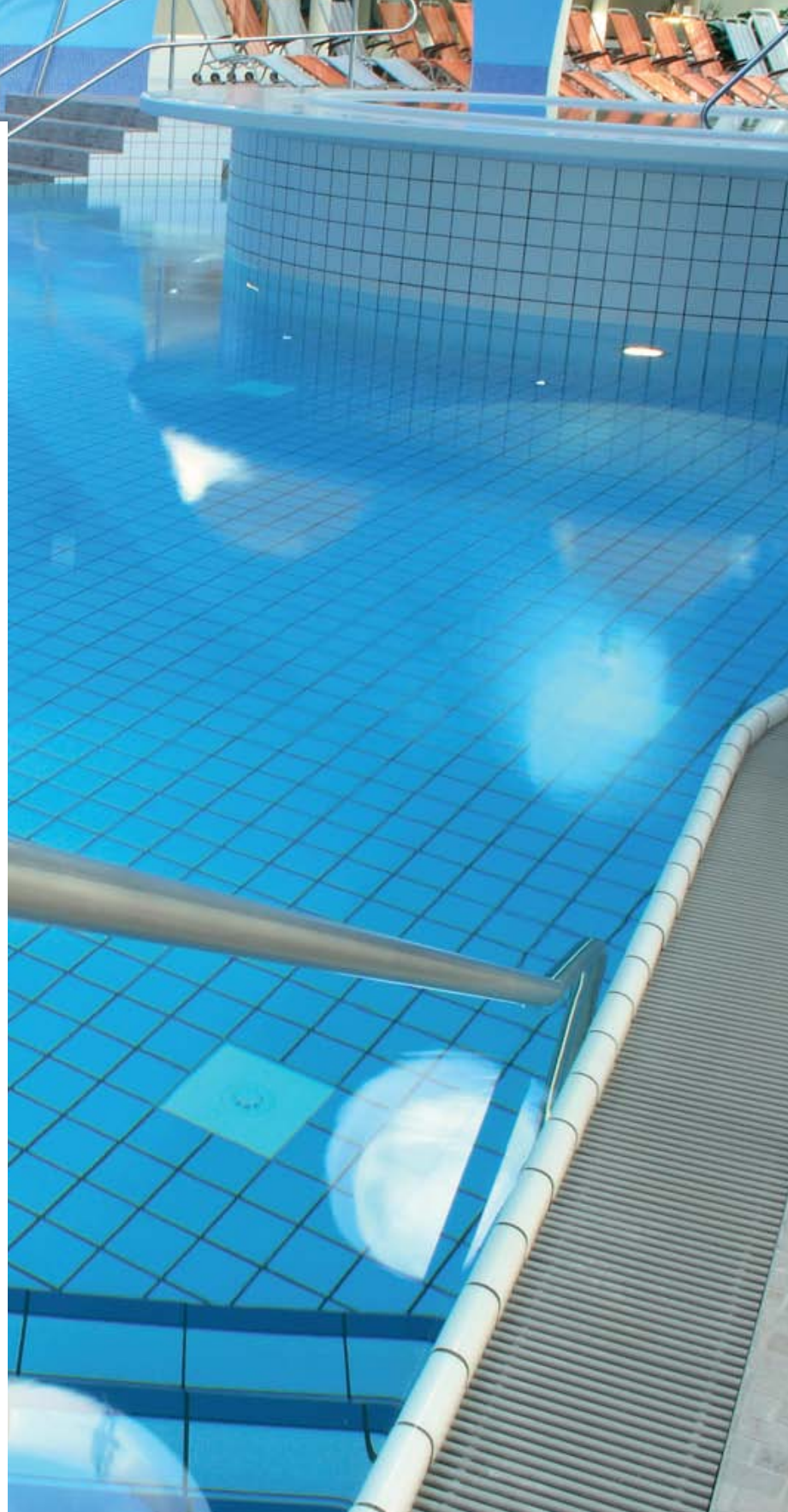
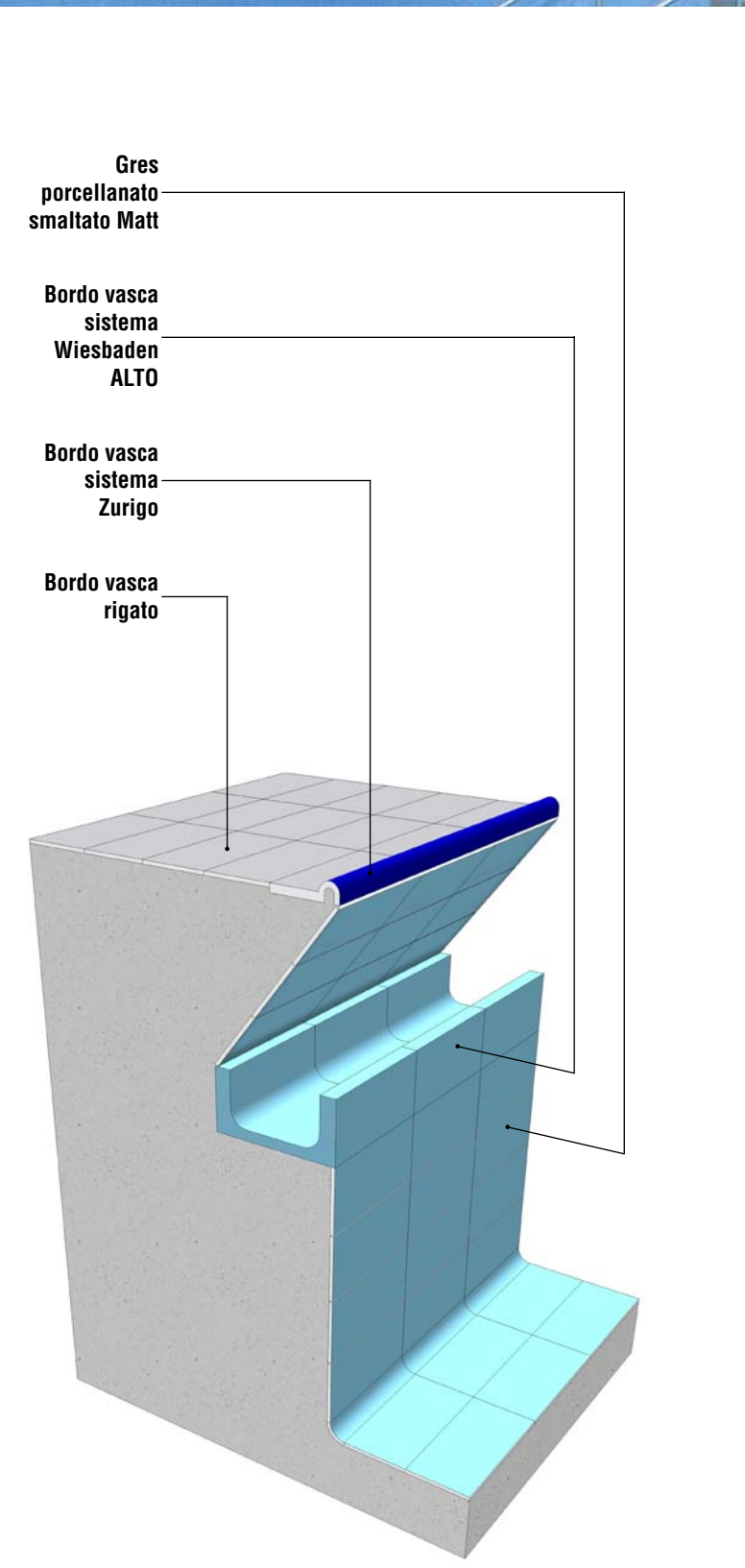

Sistema Wiesbaden
Wiesbaden System / Wiesbaden System / Système Wiesbaden / Sistema de Wiesbaden

SISTEMA WIESBADEN

WIESBADEN SYSTEM / WIESBADEN SYSTEM / SYSTÈME WIESBADEN / SISTEMA DE WIESBADEN

Gres porcellanato smaltato EN 14411 Ala

Glazed porcelain stoneware / Glasiertes Feinsteinzeug / Grès cérame émaillé / Gres porcelánico esmaltado

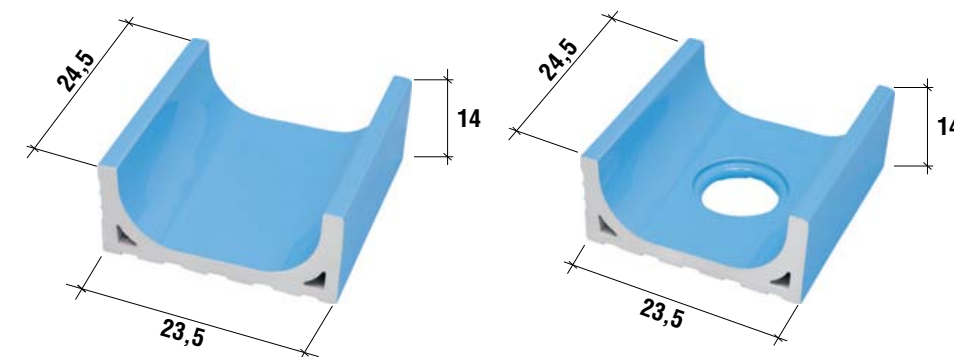

1 Canale basso

2 Canale basso con scarico

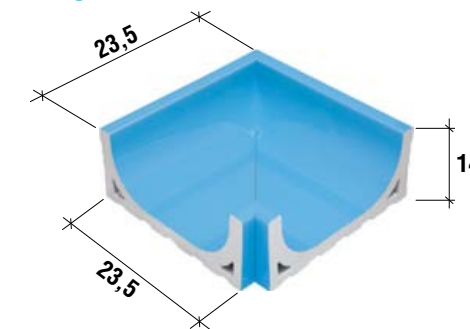

3 Canale basso angolo interno

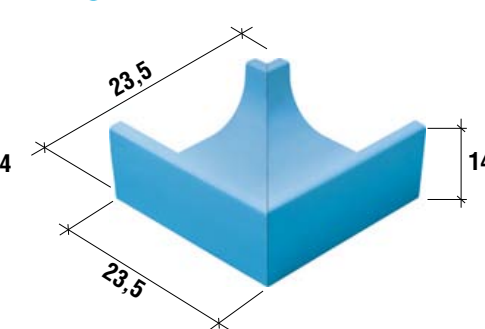

4 Canale basso angolo esterno

Canale basso
24,5x23,5 / 10" x 9 1/4"

Canale basso con scarico
24,5x23,5 / 10" x 9 1/4"

Canale basso ang. interno
13,5x23,5 / 9 1/4" x 5 1/2"

Canale basso ang. esterno
13,5x23,5 / 9 1/4" x 5 1/2"

Azzurro Caraibico 0003532 0003533 0003534 0003535

Imballi / Packing / Verpackungen / Emballages / Embalajes

Formato Size Format Formato Tamaño	Pezzi/Sc. Pcs/Box Pcs/Ctn Stck/Kart Piezas/Caja	Mq/Sc Sq./M/Box Mq/Ctn Qm/Kart Mq/Caja	Kg/Sc Kg/Box Kg/Ctn Kg/Kart Kg/Caja
1 23,5x24,5	1	0,05 / 0,03	5,02
2 23,5x24,5	1	0,05 / 0,03	5,02
3 23,5x13,5	1	0,03 / 0,01	5,1
4 23,5x13,5	1	0,03 / 0,01	5,1

MATERIALI PROGETTATI PER AMBIENTI PUBBLICI / MATERIALS DESIGNED FOR PUBLIC AREAS / FÜR ÖFFENTLICHE BEREICHE KONZIPIERTE MATERIALIEN
MATÉRIAUX CONÇUS POUR LES ESPACES PUBLICS / MATERIALES DISEÑADOS PARA ESPACIOS PÚBLICOS

Caratteristica Features Caractéristiques Eigenschaften Características	Unità di misura Unit of measurement Unité de mesure Masseinheit Unidad de medida	Valore medio Pool Collection Pool Collection mean value Valeur moyenne Pool Collection Durchschnitts-werf-Pool Collection Valor medio Pool Collection	Valore Prescritto Fixed value Valeur prescrite Vorgeschriebener wert Valor establecido	Metodo di prova Test method Méthode d'essai Prüfmethode Método de ensayo
Dimensione lati Dimensions-Length and width Masse-Länge und Breite Dimensions-Longueur et largeur Dimensiones-Longitud y ancho	%	Conforme Conform Gleichmässig Conforme Conforme	+/- 0,6 MAX	UNI EN ISO 10545-2
Rettilineità dei lati Side straightness Geractlinigkeit der Kanten Rectitude des arêtes Rectilineidad de los lados	%	Conforme Conform Gleichmässig Conforme Conforme	+/- 0,5 MAX	UNI EN ISO 10545-2
Ortogonalità degli spigoli Corner squareness Rechtwinkligkeit der Kanten Angularité Ortogonalidad de las esquinas	%	Conforme Conform Gleichmässig Conforme Conforme	+/- 0,6 MAX	UNI EN ISO 10545-2
Planarità Flatness Ebenflächigkeit Planéité Planeidad	%	Conforme Conform Gleichmässig Conforme Conforme	+/- 0,5 MAX	UNI EN ISO 10545-2
Spessore Thickness Dicke Epaisseur Grosor	%	Conforme Conform Gleichmässig Conforme Conforme	+/- 5 MAX	UNI EN ISO 10545-2
Assorbimento d'acqua Water absorption Wasseraufnahme Absorption d'eau Absorción de agua	%	Conforme Conform Gleichmässig Conforme Conforme	≤ 0,5	UNI EN ISO 10545-3
Storzo di rottura Breaking strenght Bruchkraft Contrainte de rupture Esfuerzo de rotura	N	Conforme Conform Gleichmässig Conforme Conforme	≥ 700 se sp ≥ 7 mm	UNI EN ISO 10545-4
Modulo di rottura Modulus of rupture Bruchmodul Coefficient de rupture Módulo de rotura	N/mm ²	Conforme Conform Gleichmässig Conforme Conforme	≥ 35	UNI EN ISO 10545-4
Dilatazione termica lineare Coeff. of linear thermal expansion Linearer Wärmeausdehnungskoeffizient Coeff. d'extension thermique linéaire Coeficiente de dilatación térmica lineal	°MK (-1)	Conforme Conform Gleichmässig Conforme Conforme	-	UNI EN ISO 10545-8
Resistenza agli sbalzi termici Thermal shock resistance Widerstandsfähigkeit gegen temperaturschwankungen Résistance aux écarts de température Resistencia al choque térmico	-	Resiste Resists Widerstandsfähig Résiste Resiste	-	UNI EN ISO 10545-9
Resistenza al cavillo Crazing resistant Haarrisse Résistance aux tréssaillures Resistencia al quarteado	-	Resiste Resists Widerstandsfähig Résiste Resiste	-	UNI EN ISO 10545-11
Resistenza al gelo Frost resistance Frostbeständigkeit Résistance au gel Resistencia al hielo	-	Resiste Resists Widerstandsfähig Résiste Resiste	Richiesta Request Onfrange Demande Solicitud	UNI EN ISO 10545-12
Resistenza a basse concentrazioni di acidi e alcali Resistance to low concentrations of acid and alkali Beständigkeit gegen schwach konzentrierte Sauren und Laugen Resistance a de basses concentrations d'acides et bases Resistencia a bajas concentraciones de acidos y alcalis	-	GLA	-	UNI EN ISO 10545-13
Resistenza ai prodotti chimici di uso domestico Resistance to chemicals for household use Beständigkeit gegen haushaltschemikalien Resistance aux produits chimiques d'usage domestique Resistencia a los productos quimicos de uso doméstico	-	GA	Min GB	UNI EN ISO 10545-13
Resistenza alle macchie Stain resistant Flecken beständigkeit Résistance au tâches Resistencia a las manchas	-	Conforme Conform Gleichmässig Conforme Conforme	3	UNI EN ISO 10545-14



CERDISA 
Pool Collection

Uffici commerciali:
Via Statale, n° 99/D
42013 Dinazzano di Casalgrande - RE
Tel. +39 0522 773.611
Fax +39 0522 773.659/60
www.ceramichecerdisa.it
marketing@cerdisa.biz

**RICCHETTI
GROUP**
 **cc**